

# PALLET DESIGN SYSTEM Version 5.4

## Pallet Specification Sheet

All dimensions in millimeters

**Customer:**

**Prepared by:**

Express Pallets & Crates Pty Ltd  
PDS License: 790 Printed: March 09, 2020

**Pallet ID:** VP1165753HW

**Classification:** 1165 x 1165, Stringer-Class, Double-Face Non-Reversible, 2-Way, Reusable, New Manufacture

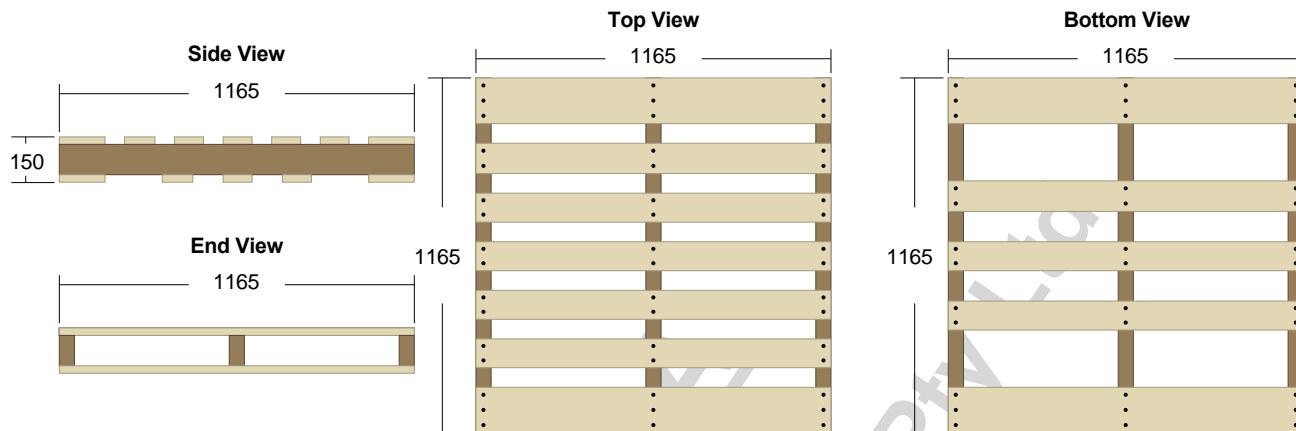

### Components

### Materials

#### Top Deck:

Style: Deckboard Type: New Lumber

Number	Thickness	Width	Length
4	25	95	1165
1	25	100	1165
2	25	150	1165

Volume: 0.0227 cubic meters

#### Bottom Deck:

Style: Deckboard Type: New Lumber

Number	Thickness	Width	Length
2	25	95	1165
1	25	100	1165
2	25	150	1165

Volume: 0.0172 cubic meters

#### Stringers:

Type: New Lumber

Number	Width	Height	Length
3	50	100	1165

Volume: 0.0175 cubic meters

#### Fasteners:

Fastener ID:	57x3.06
Fastener Type:	Helically Threaded Nail
Fastener Length:	57
Thread Length:	38
Thread Diameter:	3.4
Wire Diameter:	3.1
Head Diameter:	7.2
Flutes:	2
Helixes:	4.1
Pitch:	9.3
Thread Angle:	60
MIBANT Angle:	35
FWC:	1.71
Total Number:	84

#### New Lumber:

Lumber ID: HARD WOOD

Species Class	Grade
Eucalyptus grandis	Standard &BTR

Moisture Content (at manufacture and assembly): Green

Total New Lumber Volume: 0.0574 cubic meters

### Spec Sheet Notes:

# PALLET DESIGN SYSTEM Version 5.4

## Pallet Structural Analysis

**Customer:**

**Prepared by:**

Express Pallets & Crates Pty Ltd

PDS License: 790 Printed: March 09, 2020

**Pallet ID:** VP1165753HW

**Classification:** 1165 x 1165, Stringer-Class, Double-Face Non-Reversible, 2-Way, Reusable, New Manufacture

**General Load Type:** Uniformly Distributed - Full Pallet Coverage

**Load Weight Variability:** Medium

**Service Environment:** Dry Environment (EMC <= 19%)

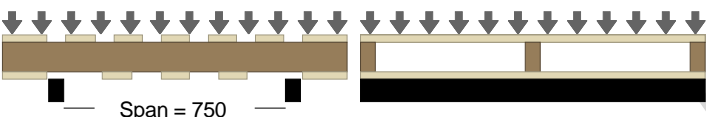
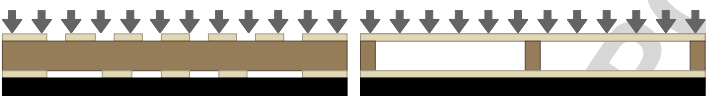
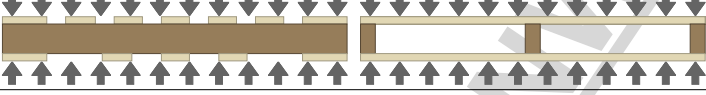
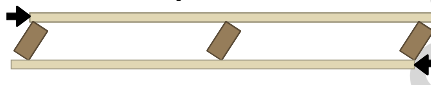
Support Condition	Safe Maximum Load	Deflection at Maximum Load	User Specified Deflection Limit	Maximum Load for Deflection Limit	Critical Member or Connection
<p><b>Racked Across Length</b> <u>2 Beam Support</u></p>  <p>Span = 750</p>	4919 kg	7 mm	----	----	Interior Top Deckboard
<p><b>Warehouse Storage</b> <u>Stacked 1 Unit Load High</u></p> 	6673 kg	7 mm	6 mm	NA	Interior Top Deckboard
<p><u>Stacked 2 Unit Loads High</u></p> 	4171 kg per pallet	7 mm	6 mm	NA	Interior Top Deckboard
<p><b>Lateral Collapse Resistance</b></p>  <p style="text-align: center;">Low                      Medium                      Good                      Excellent</p> <p style="text-align: center;">LCR Indicator = 1.37</p>					

### Pallet Design System (PDS)

Developed and owned by:

**National Wooden Pallet and Container Association (NWPCA)**

Research and development for early versions of PDS were conducted in cooperation with:  
 Center for Unit Load Design, Virginia Tech Department of Wood Science and Forest Products;  
 U.S.D.A. Forest Service and Forest Products Laboratory; APA - The Engineered Wood Association;  
 Software Technologies Laboratory, Virginia Tech Department of Industrial and Systems Engineering

The results from PDS are based on the NWPCA's continuing program of laboratory and field research. While the engineering outcomes reflected in the results are based on sound science, the quality of workmanship, the input data, and the conditions in which pallets are used may vary widely. Therefore, the Association cannot accept responsibility for pallet performance or design as actually constructed, and specifically disclaims any responsibility for such. Notwithstanding the history of the PDS system, users of the PDS system are strongly encouraged to undertake individual, unique analysis of the results as they then pertain to specific applications and the production process. Wood pallets manufactured to this PDS design are for the sole purpose of storing and/or transporting material. Under no circumstance should any person stand, step, or lean upon them or otherwise use them for support.

Pallet Design System - Version 5.4 (C) Copyright 1985-2018

National Wooden Pallet and Container Association, 1421 Prince Street, Suite 340, Alexandria, Virginia 22314-2805, United States

<http://www.palletcentral.com>

All Rights Reserved

# PALLET DESIGN SYSTEM Version 5.4

## Pallet Physical Property Analysis

**Customer:**

**Prepared by:**

Express Pallets & Crates Pty Ltd

PDS License: 790 Printed: March 09, 2020

**Pallet ID:** VP1165753HW

**Classification:** 1165 x 1165, Stringer-Class, Double-Face Non-Reversible, 2-Way, Reusable, New Manufacture

	At Manufacture	At 25% MC	At 19% MC	At 15% MC	At 12% MC
<b>Average Pallet Weight</b>	38 kg	32 kg	30 kg	29 kg	28 kg



Component	Original Dimension	Shrinkage from Manufacture to 19% MC	Shrinkage from Manufacture to 15% MC
Top Deckboards	25 mm Thickness	0.4 mm (+/- 0.1 mm)	0.5 mm (+/- 0.1 mm)
	95 mm Width	1.4 mm (+/- 0.3 mm)	2.0 mm (+/- 0.5 mm)
	100 mm Width	1.4 mm (+/- 0.3 mm)	2.1 mm (+/- 0.5 mm)
	150 mm Width	2.1 mm (+/- 0.5 mm)	3.1 mm (+/- 0.7 mm)
Stringers	100 mm Height	1.4 mm (+/- 0.3 mm)	2.1 mm (+/- 0.5 mm)
	50 mm Width	0.7 mm (+/- 0.2 mm)	1.0 mm (+/- 0.2 mm)
Bottom Deckboards	25 mm Thickness	0.4 mm (+/- 0.1 mm)	0.5 mm (+/- 0.1 mm)
	95 mm Width	1.4 mm (+/- 0.3 mm)	2.0 mm (+/- 0.5 mm)
	100 mm Width	1.4 mm (+/- 0.3 mm)	2.1 mm (+/- 0.5 mm)
	150 mm Width	2.1 mm (+/- 0.5 mm)	3.1 mm (+/- 0.7 mm)

Property of NWPCA  
Express Pallets & Crates Pty Ltd  
PDS License: 790

# PALLET DESIGN SYSTEM Version 5.4

## 2-D Pallet Drawings

All dimensions in millimeters

Pallet ID: VP1165753HW

Classification: 1165 x 1165, Stringer-Class, Double-Face Non-Reversible, 2-Way, Reusable, New Manufacture

### Side View

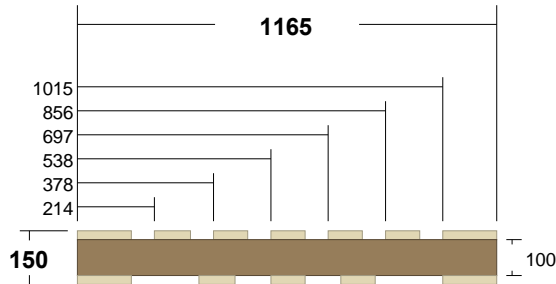

### End View

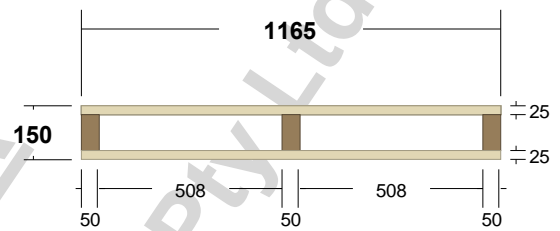

### Top View

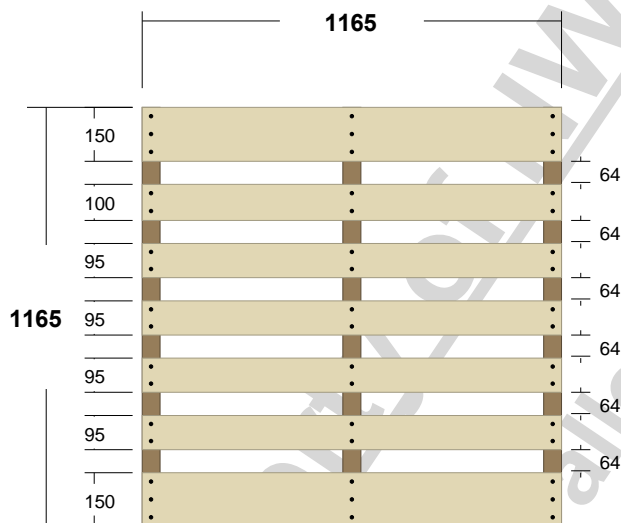

### Bottom View

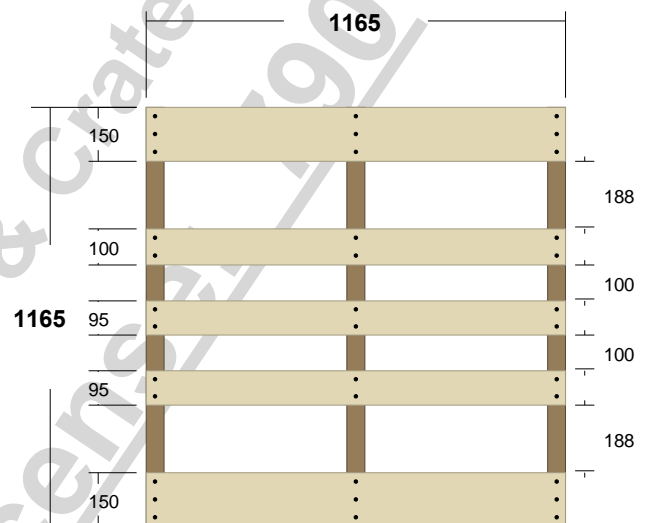

All output generated from the PDS software (including without limitation the designs, drawings, plans, specification sheets, data, analyses, information, materials or other output produced by or with the assistance of the Software (PDS Output) are protected by copyright and other intellectual property laws and cannot be reproduced without the prior written consent of NWPCA. Lessee may provide a copy of the Output, which must bear the Lessee's watermark, to its manufacturer for the sole purpose of manufacturing the pallet for Lessee to sell or to its direct pallet customer for the sole purpose of selling pallets to that customer.

Customer:

Prepared by:

Express Pallets & Crates Pty Ltd

PDS License: 790 Printed: March 09, 2020

# PALLET DESIGN SYSTEM Version 5.4

## Pallet Drawing - Side and End View

All dimensions in millimeters

Pallet ID: VP1165753HW

Classification: 1165 x 1165, Stringer-Class, Double-Face Non-Reversible, 2-Way, Reusable, New Manufacture

### Side View

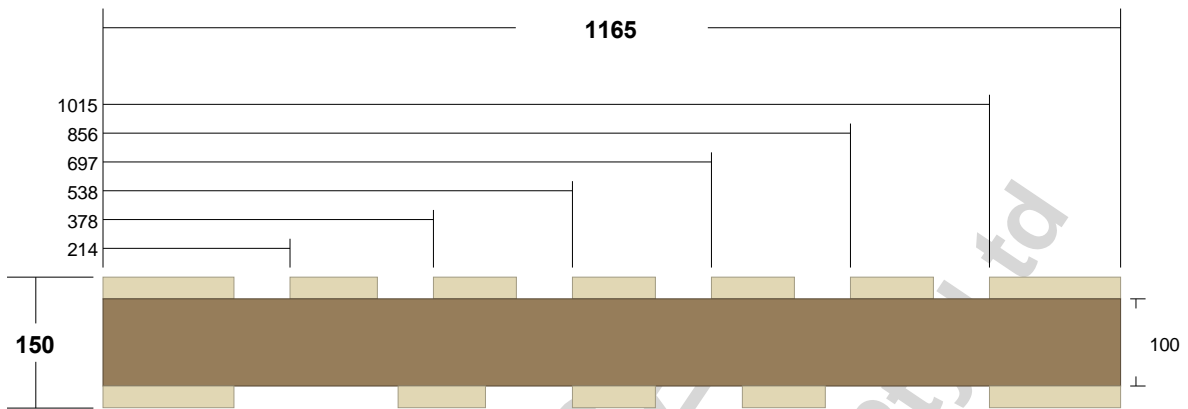

### End View

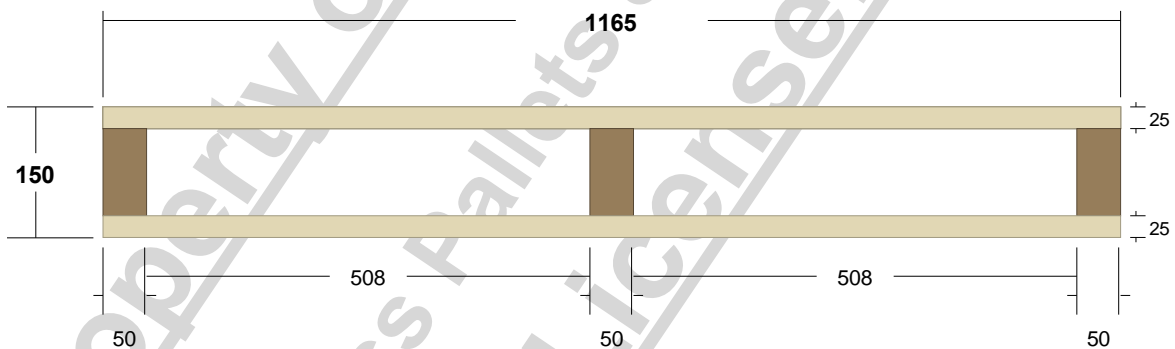

All output generated from the PDS software (including without limitation the designs, drawings, plans, specification sheets, data, analyses, information, materials or other output produced by or with the assistance of the Software (PDS Output) are protected by copyright and other intellectual property laws and cannot be reproduced without the prior written consent of NWP. Lessee may provide a copy of the Output, which must bear the Lessee's watermark, to its manufacturer for the sole purpose of manufacturing the pallet for Lessee to sell or to its direct pallet customer for the sole purpose of selling pallets to that customer.

Customer:

Prepared by:

Express Pallets & Crates Pty Ltd  
PDS License: 790 Printed: March 09, 2020

# PALLET DESIGN SYSTEM Version 5.4

## Pallet Drawing - Top View

All dimensions in millimeters

Pallet ID: VP1165753HW

Classification: 1165 x 1165, Stringer-Class, Double-Face Non-Reversible, 2-Way, Reusable, New Manufacture

### Top View

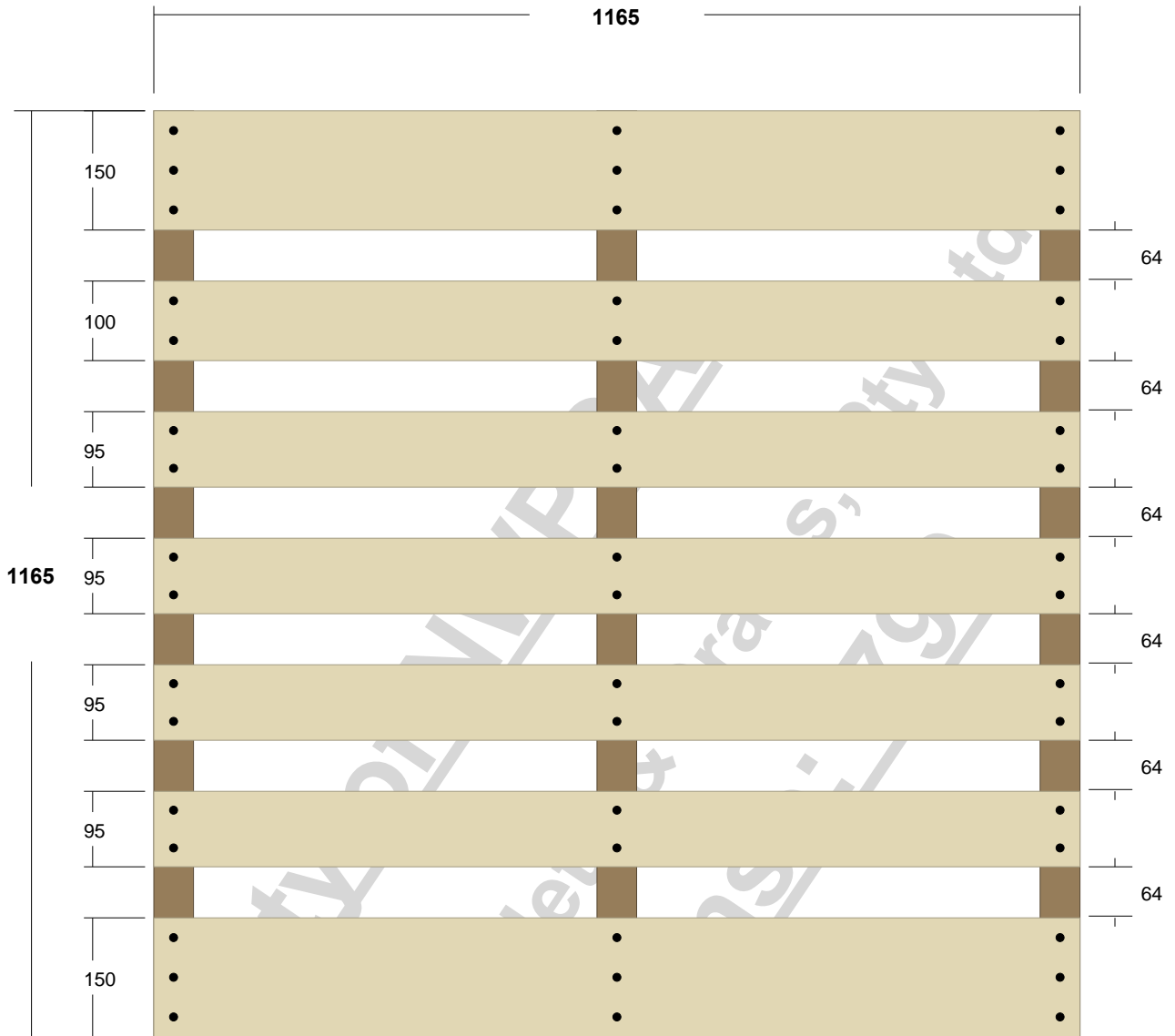

Customer:

Prepared by:

Express Pallets & Crates Pty Ltd  
PDS License: 790 Printed: March 09, 2020

# PALLET DESIGN SYSTEM Version 5.4

## Pallet Drawing - Bottom View

All dimensions in millimeters

Pallet ID: VP1165753HW

Classification: 1165 x 1165, Stringer-Class, Double-Face Non-Reversible, 2-Way, Reusable, New Manufacture

### Bottom View

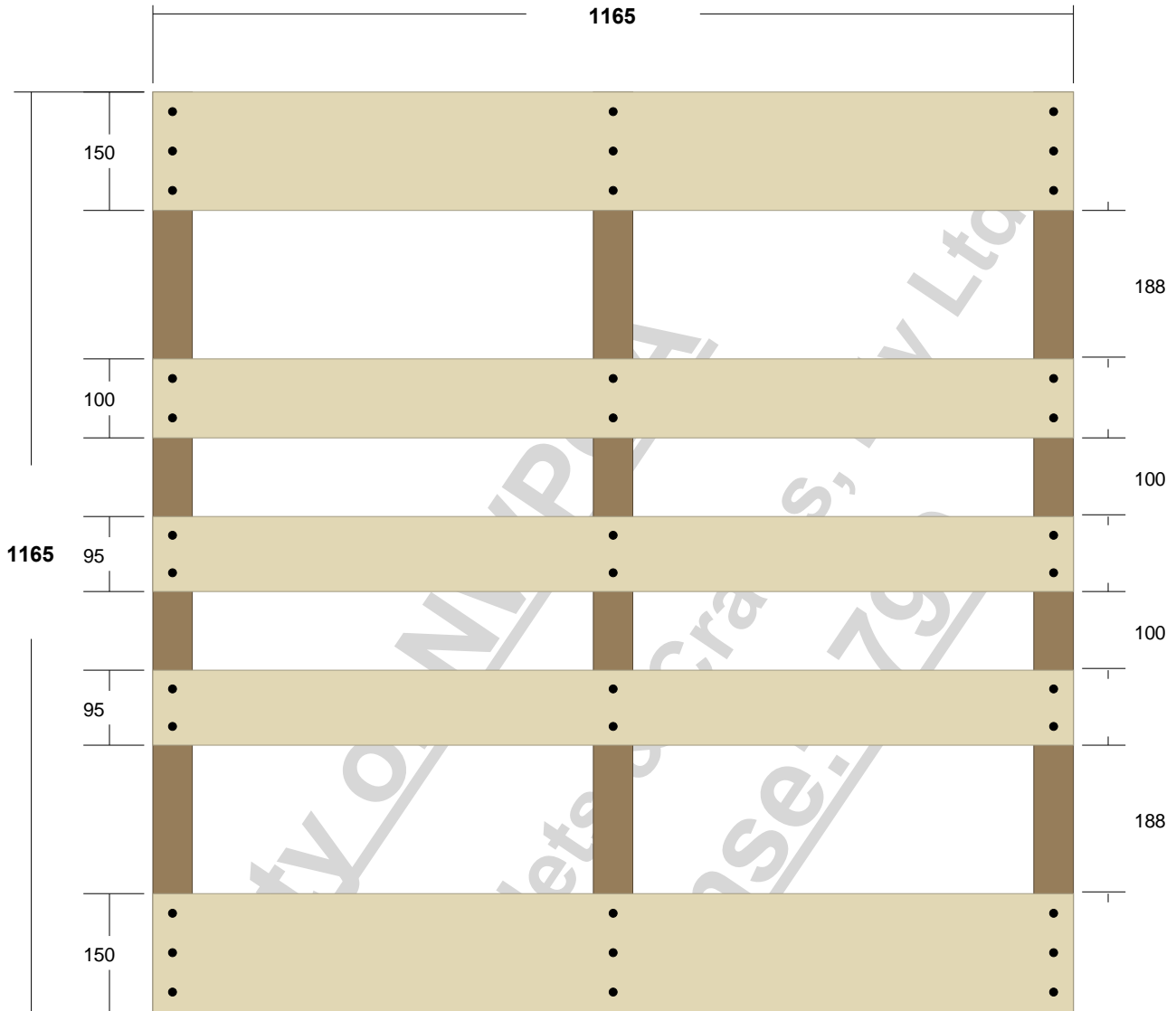

Customer:

Prepared by:

Express Pallets & Crates Pty Ltd  
PDS License: 790 Printed: March 09, 2020

# PALLET DESIGN SYSTEM Version 5.4

## 3-D Pallet Drawings

All dimensions in millimeters

Pallet ID: VP1165753HW

Classification: 1165 x 1165, Stringer-Class, Double-Face Non-Reversible, 2-Way, Reusable, New Manufacture

Top View

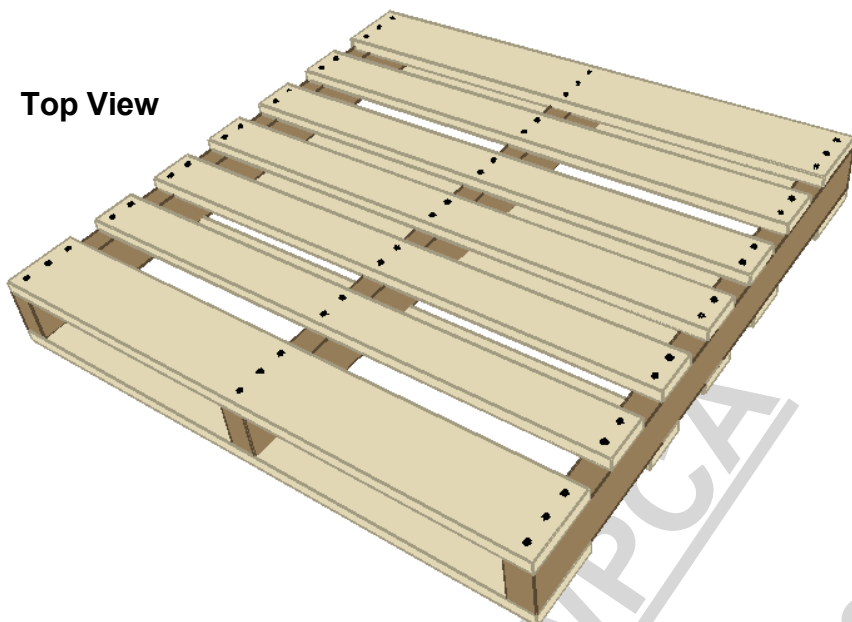

Bottom View

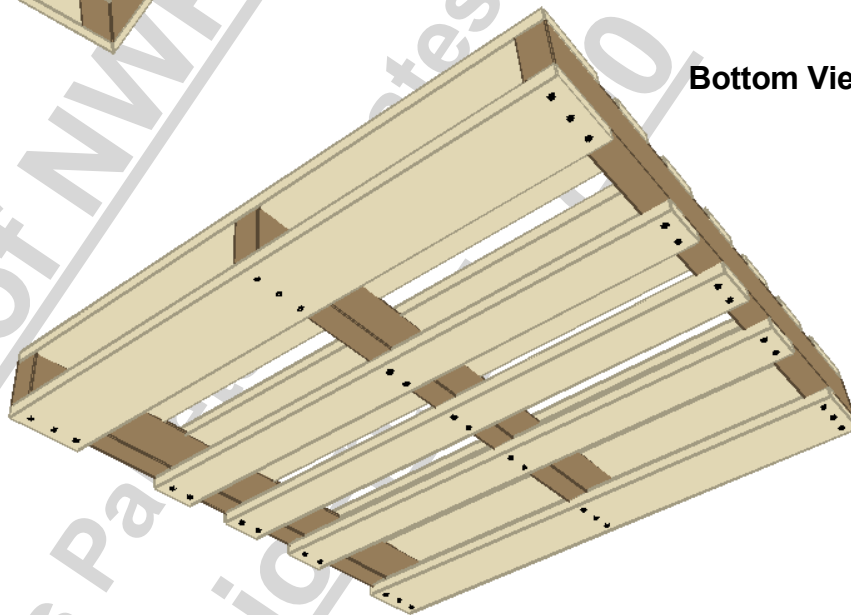

All output generated from the PDS software (including without limitation the designs, drawings, plans, specification sheets, data, analyses, information, materials or other output produced by or with the assistance of the Software (PDS Output) are protected by copyright and other intellectual property laws and cannot be reproduced without the prior written consent of NWPCA. Lessee may provide a copy of the Output, which must bear the Lessee's watermark, to its manufacturer for the sole purpose of manufacturing the pallet for Lessee to sell or to its direct pallet customer for the sole purpose of selling pallets to that customer.

**Customer:**

**Prepared by:**

Express Pallets & Crates Pty Ltd

PDS License: 790 Printed: March 09, 2020